

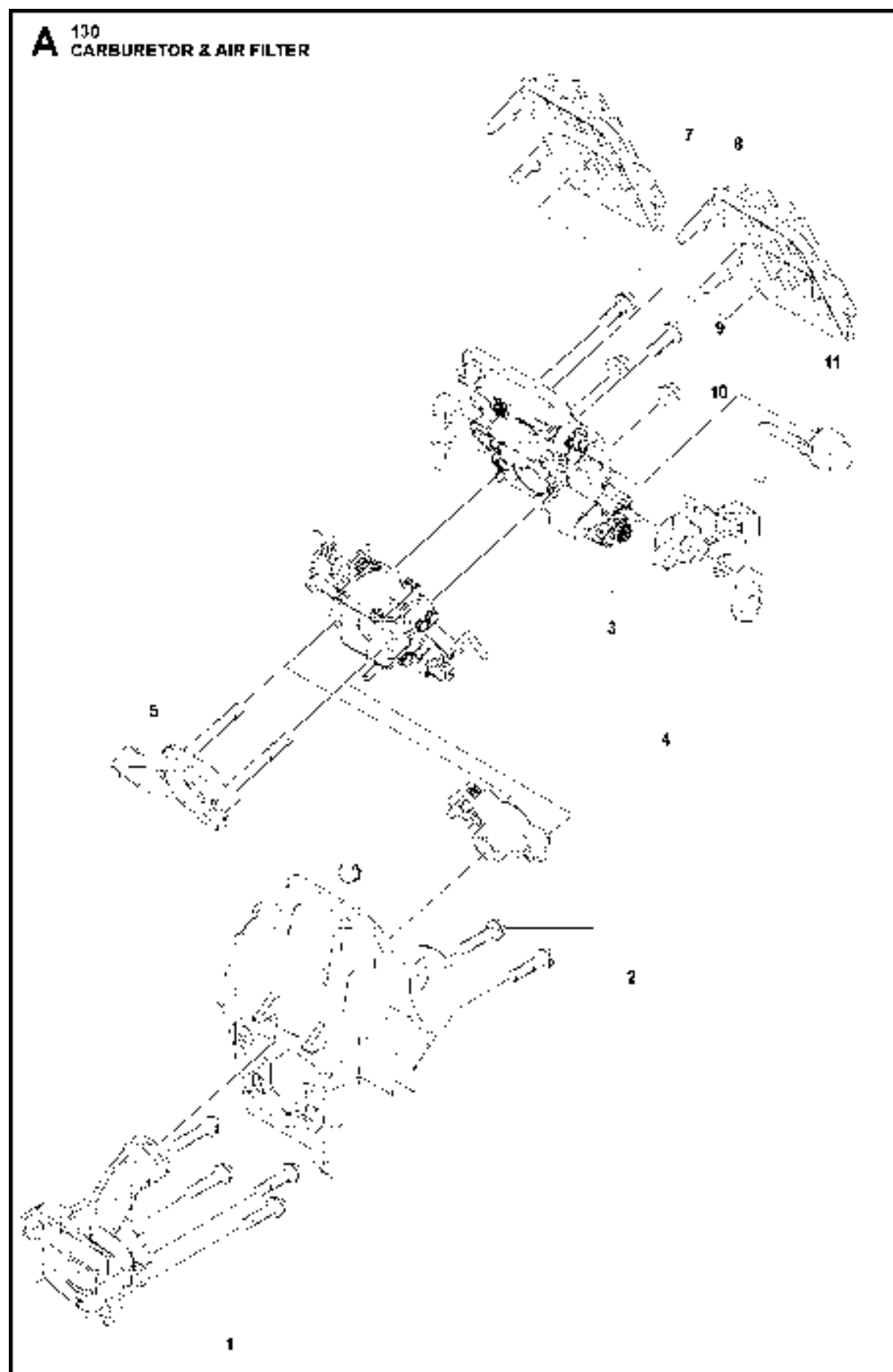

SPARE PARTS LIST

CHAIN SAWS

130

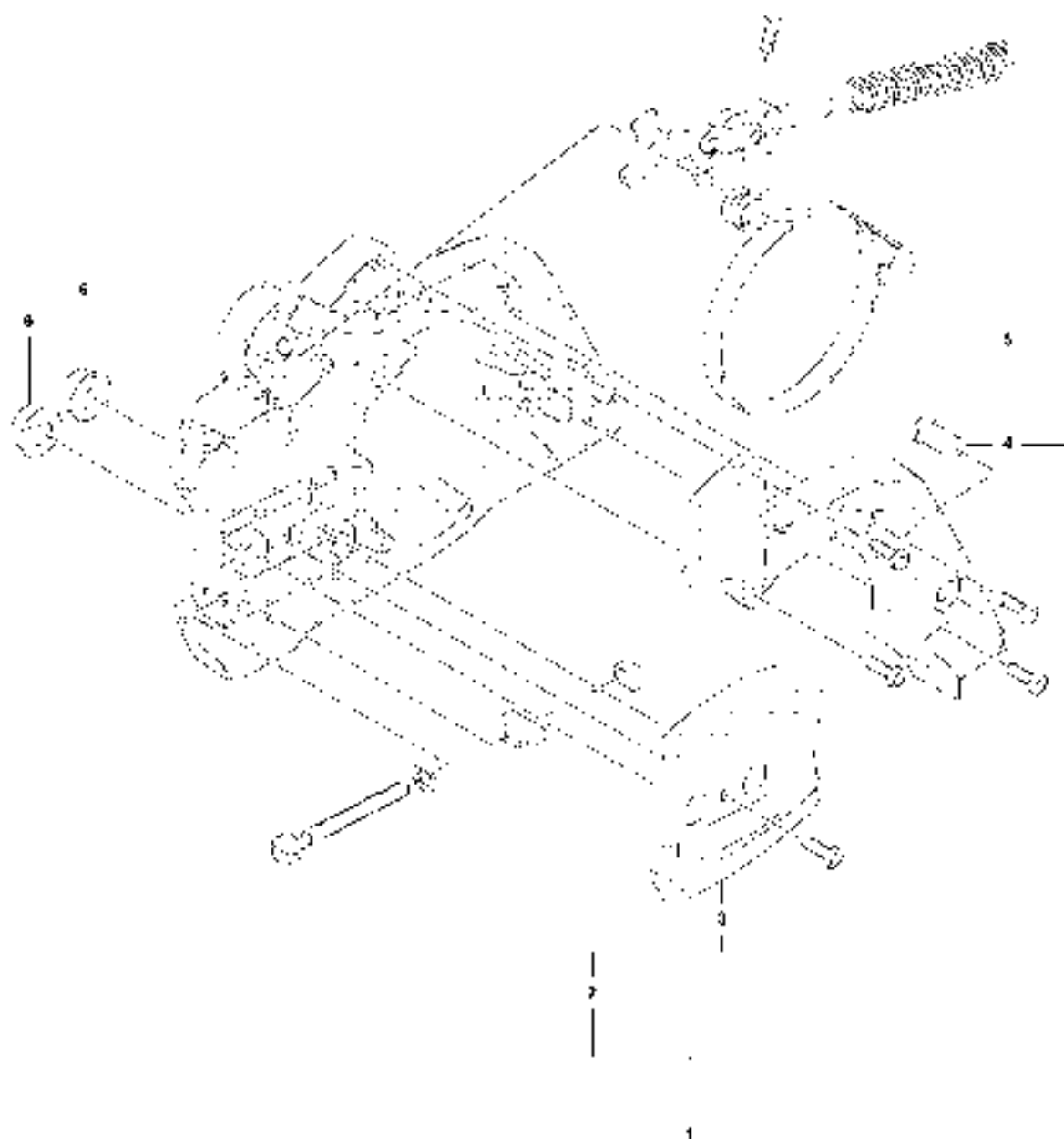

Ref	Part No	Description	Remark	QTY KIT
1	591 46 39-01	INLET	Intake Boot	1
2	591 46 44-01	SERVICE KIT	Insulation Wall	1
3	591 46 45-01	SERVICE KIT	Filter Holder	1
4	599 82 37-01	CARBURETTOR KIT	NA, EU, CN, AU, NZ - up to s/n 20205099999	1
4	599 82 37-02	CARBURETTOR KIT	RU, BR - up to s/n 20205099999	1
4	599 82 37-03	CARBURETTOR KIT	NA, EU, CN, AU, NZ From s/n 20205100001 -	1
4	599 82 37-04	CARBURETTOR KIT	RU, BR From s/n 20205100001 -	1
5	589 28 92-01	FLANGE		1
7	588 22 93-01	AIR FILTER	Mesh Filter	1
8	588 22 93-02	AIR FILTER	Non-Woven Filter	1
9	503 21 70-10	SCREW CCRPANT		2
10	530 01 61-01	NUT		2
11	503 93 66-01	PURGE		1

B 130
CHAIN BRAKE & CLUTCH COVER

Ref	Part No	Description	Remark	QTY	KIT
1	591 46 47-01	SERVICE KIT	Clutch Cover	1	
2	591 46 46-01	SERVICE KIT	Bar Adjuster	1	1
3	582 64 76-01	GUIDE PLATE		1	1,2
4	590 43 96-01	GUIDE BUSHING		1	
5	544 30 60-01	BRAKE BAND ASSY		1	1
6	530 01 59-17	NUT		2	

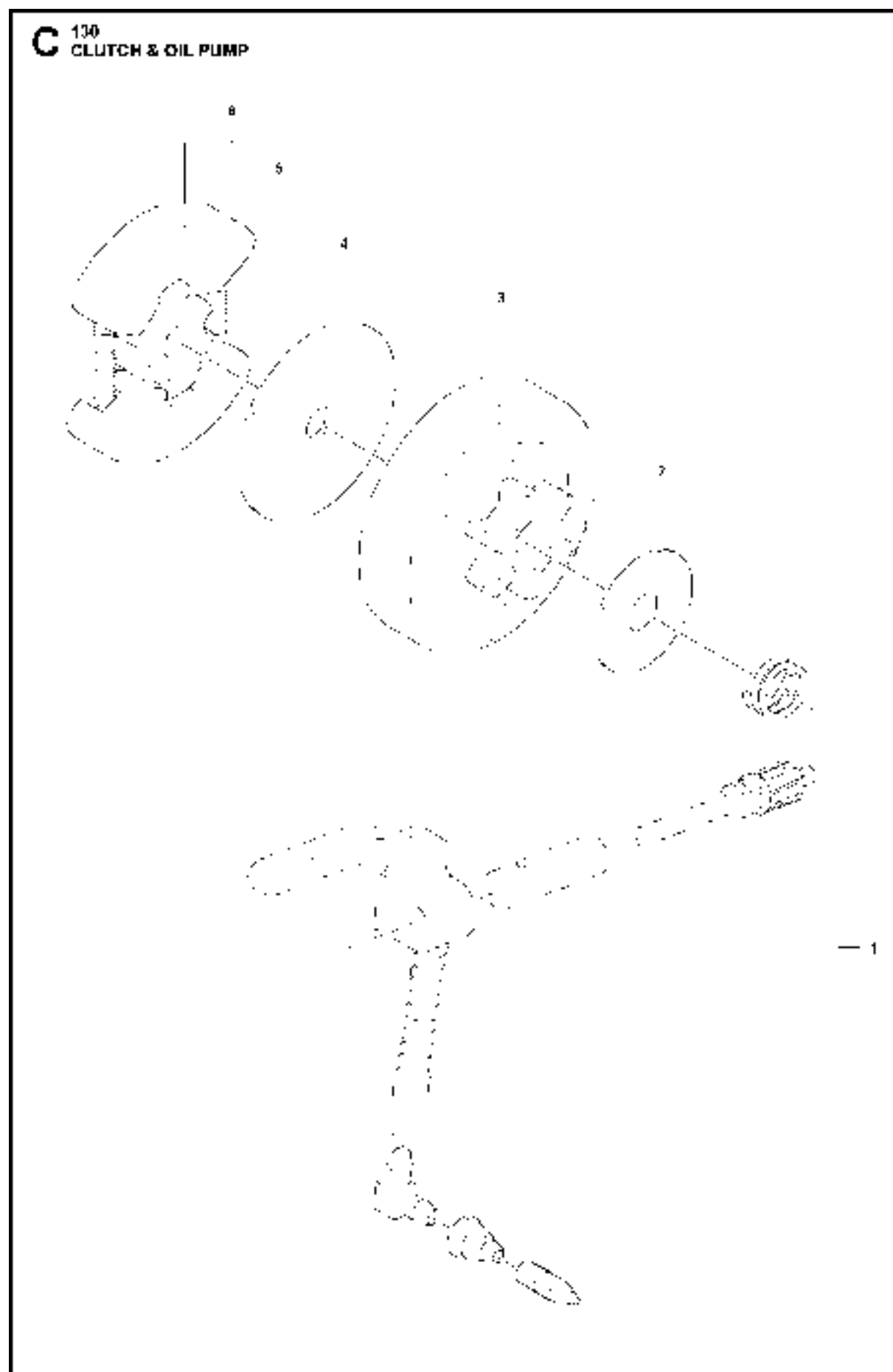

Ref	Part No	Description	Remark	QTY	KIT
1	591 46 68-01	SERVICE KIT	OIL PUMP	1	
2	579 62 15-01	WASHER		1	
3	582 59 84-01	CLUTCH DRUM ASSY		1	
4	530 01 56-11	WASHER		1	
5	599 58 85-01	SPRING		1	6
6	599 58 86-01	CLUTCH		1	

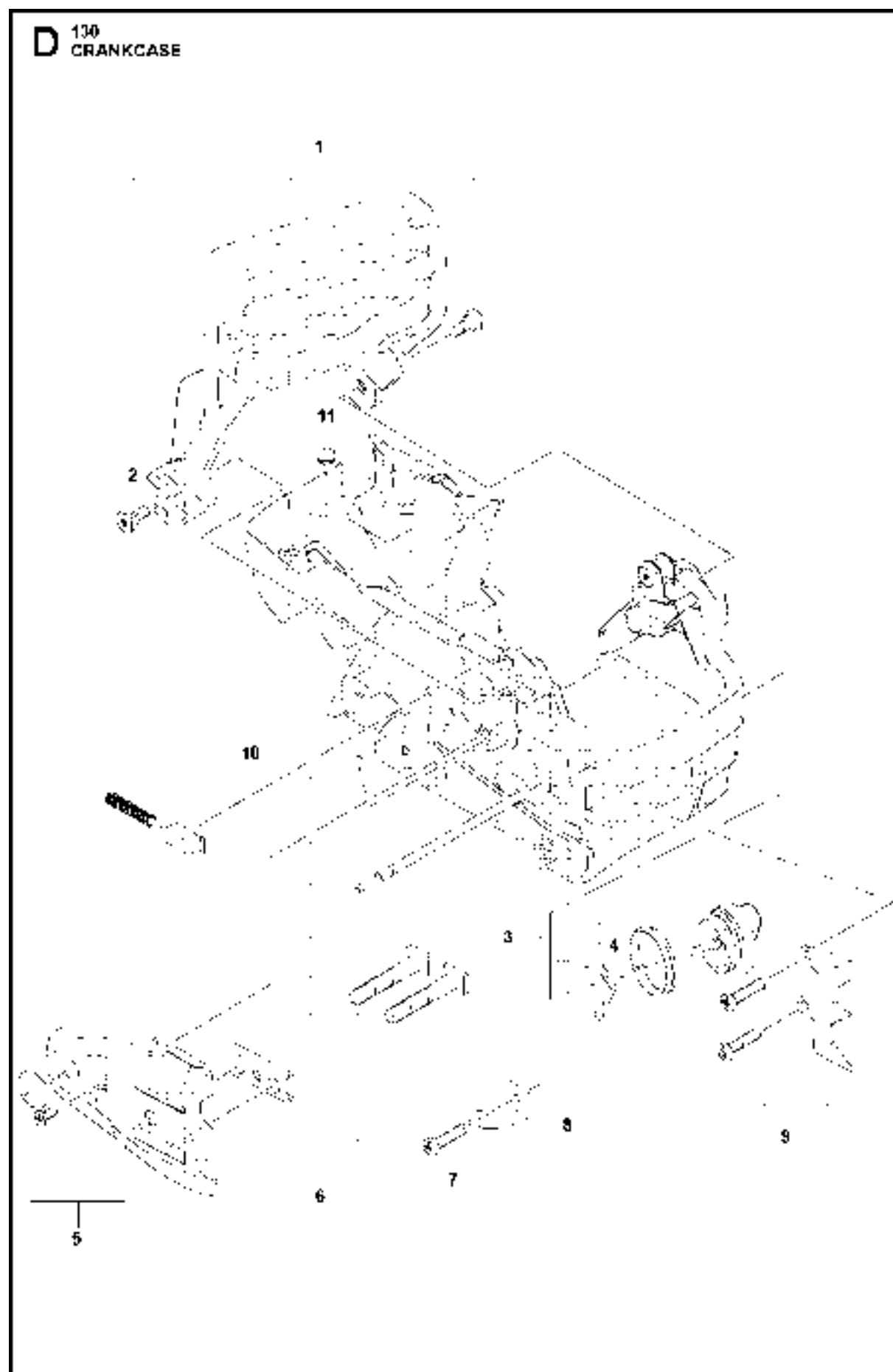

Ref	Part No	Description	Remark	QTY	KIT
1	591 46 48-01	SERVICE KIT	Hand Guard	1	
2	545 12 73-01	BOSS	SCREW	2	
3	544 11 12-03	TANK CAP ASSY		1	10
4	589 24 11-01	GASKET		1	3,10
5	591 46 49-01	SERVICE KIT	Bar Plate	1	
6	591 46 50-01	SERVICE KIT	Bar Bolt	1	
7	530 01 64-32	SCREW		1	
8	530 02 98-50	CHAIN CATCHER		1	
9	530 01 43-81	FELLING DOG	Spike Assembly Kit	1	
10	591 46 53-01	SERVICE KIT	Chassis	1	
11	540 05 73-01	SUPPORT		1	

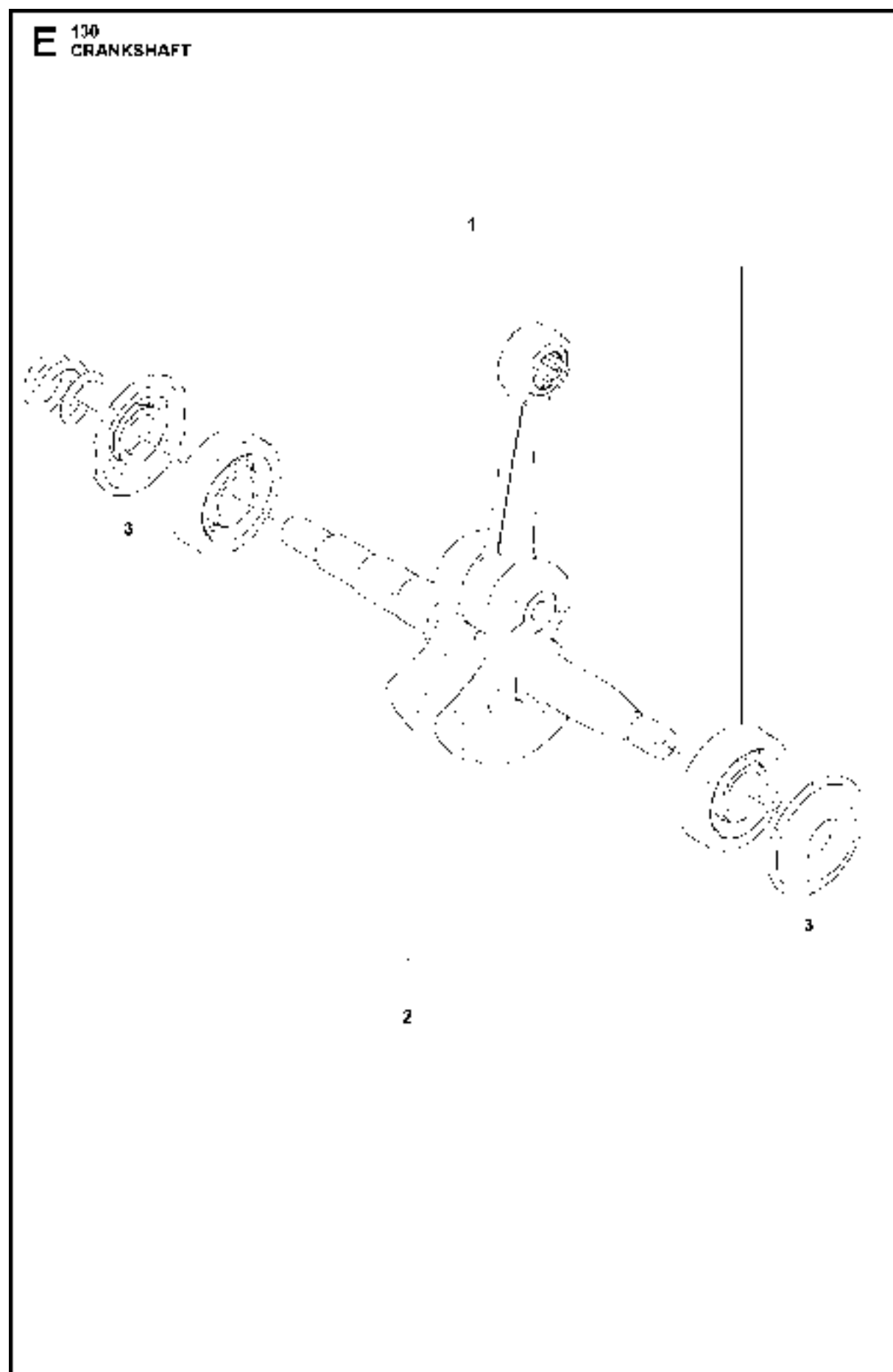

Ref	Part No	Description	Remark	QTY KIT
1	588 61 96-01	CRANKSHAFT ASSY		1
2	591 46 54-01	BEARING KIT	CRANKSHAFT SEAL & BEARING	1
3	595 31 41-01	SEAL		2

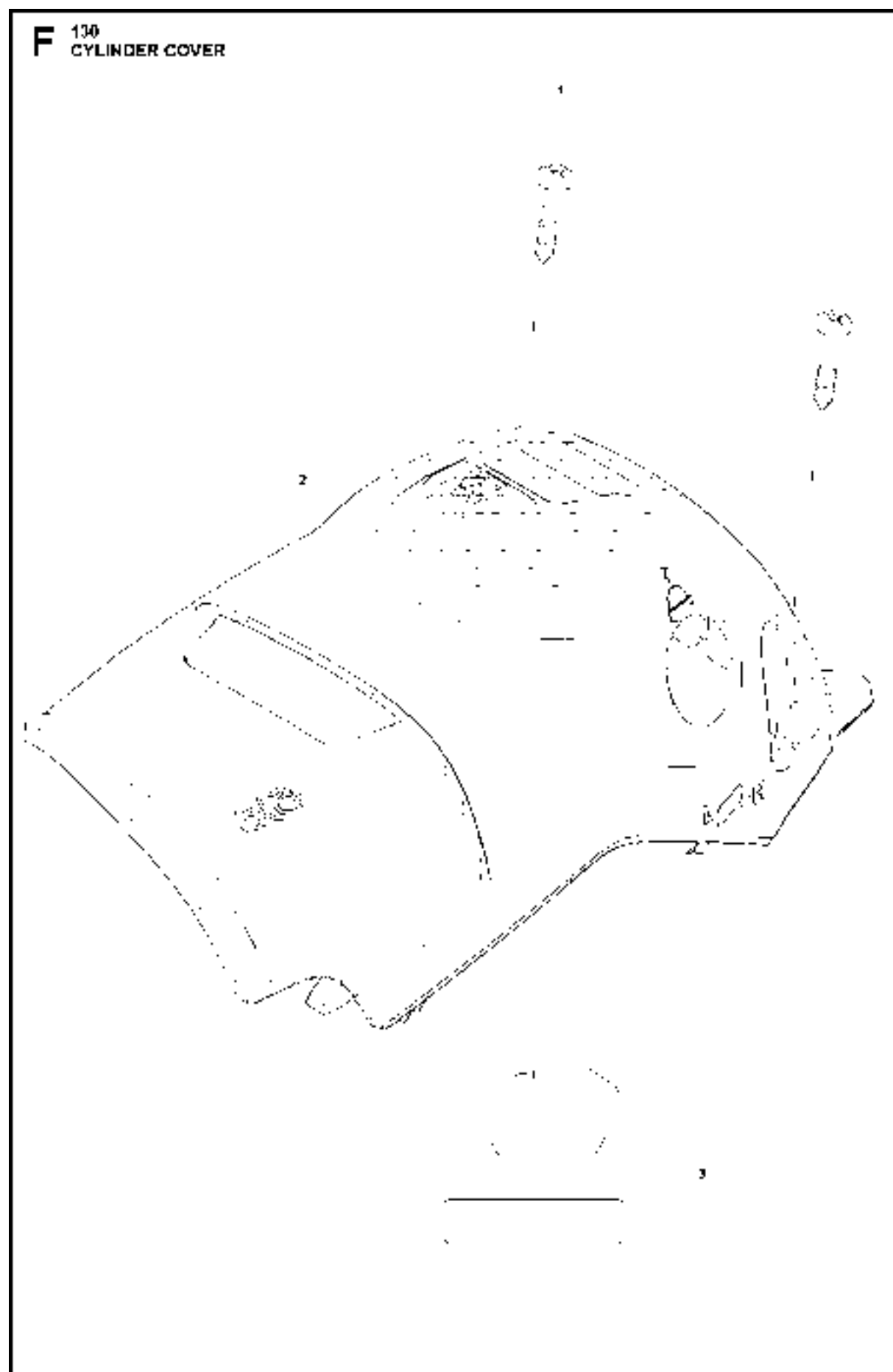

Ref	Part No	Description	Remark	QTY KIT
1	503 20 34-76	SCREW		3
2	596 39 48-01	COVER	CYLINDER	1
3	591 46 55-01	SERVICE KIT	DECAL KIT	1

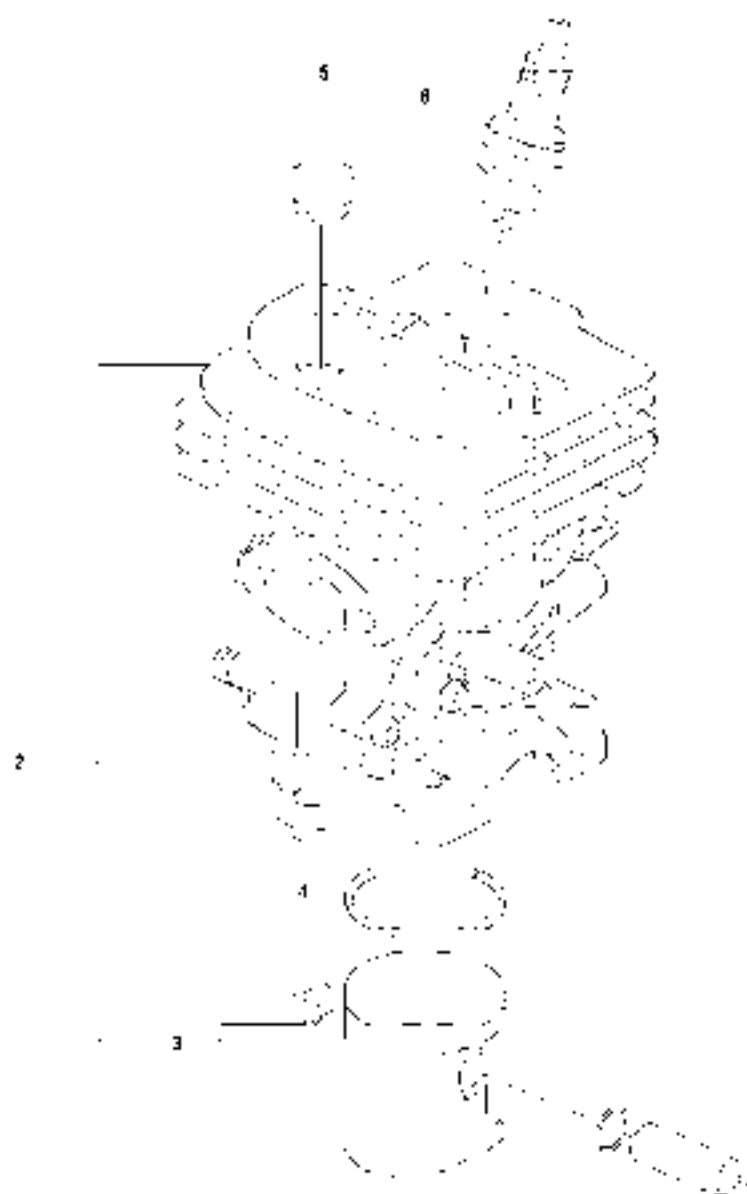
G 130
CYLINDER PISTON

1
Piston Pin

2
Piston Skirt

3
Piston Crown

Ref	Part No	Description	Remark	QTY	KIT
1	591 46 56-01	SERVICE KIT	Cylinder Bolt	1	
2	591 46 57-01	SERVICE KIT	Cylinder & Piston	1	
3	591 46 57-02	SERVICE KIT	Piston Kit	1	2
4	585 04 06-01	PISTON RING		1	2,3
5	590 40 99-01	SUPPORT		1	
6	503 23 51-11	SPARK PLUG	NGK BPMR7A	1	

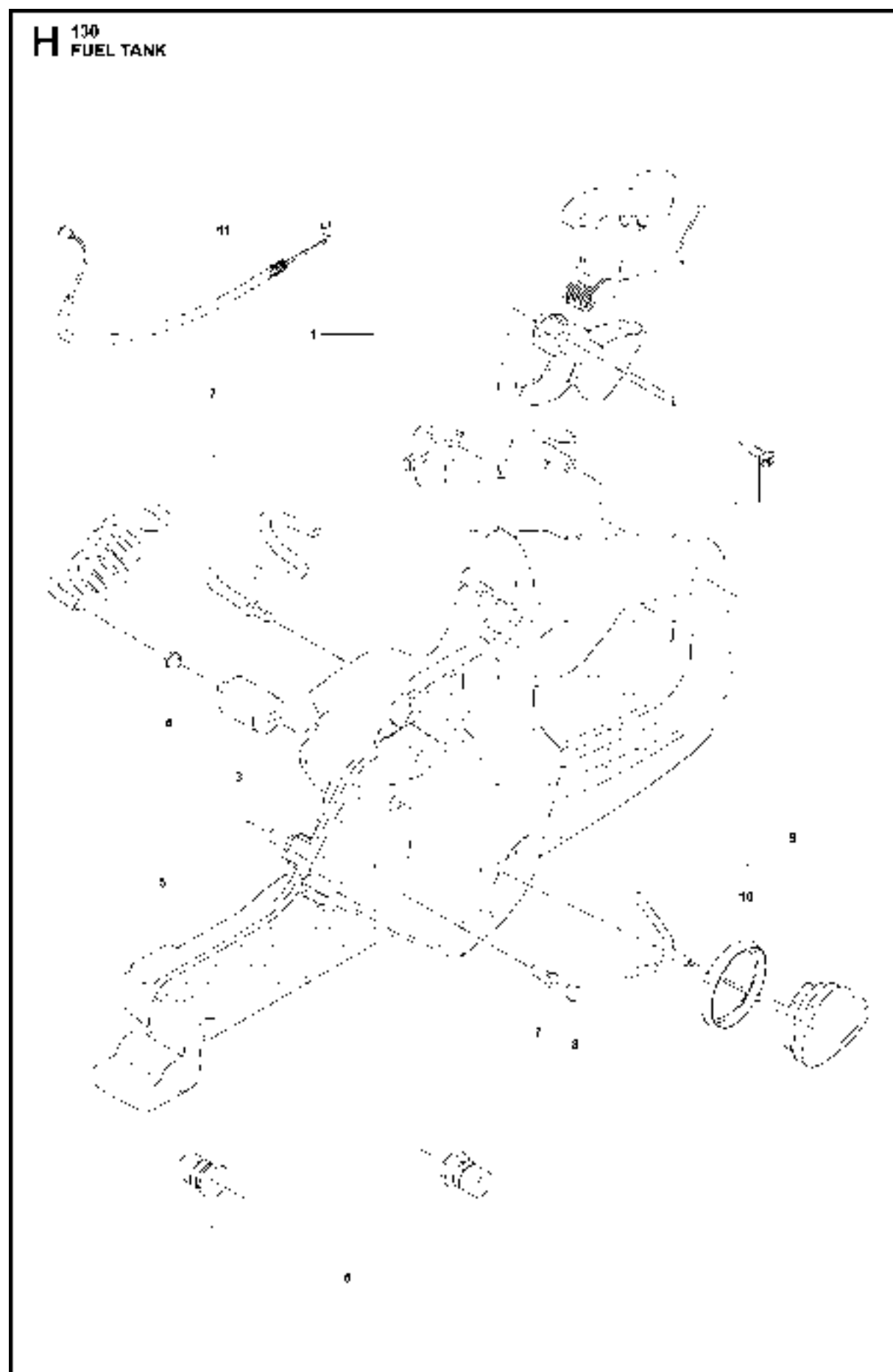

Ref	Part No	Description	Remark	QTY	KIT
1	591 46 60-01	SERVICE KIT	Trigger Assembly	1	
2	592 85 44-01	SERVICE KIT	Fuel Hose	1	
3	503 44 32-01	FUEL FILTER		1	
4	503 73 58-01	BUSHING		1	
5	501 51 84-02	FUEL TANK ASSY		1	
6	591 46 58-01	SERVICE KIT	Lateral Support	1	
7	530 02 61-19	CHECK VALVE		1	
8	530 02 98-68	PLUG		1	
9	544 11 12-03	TANK CAP ASSY		1	
10	589 24 11-01	GASKET		1	9
11	582 28 70-01	THROTTLE CABLE ASSY		1	

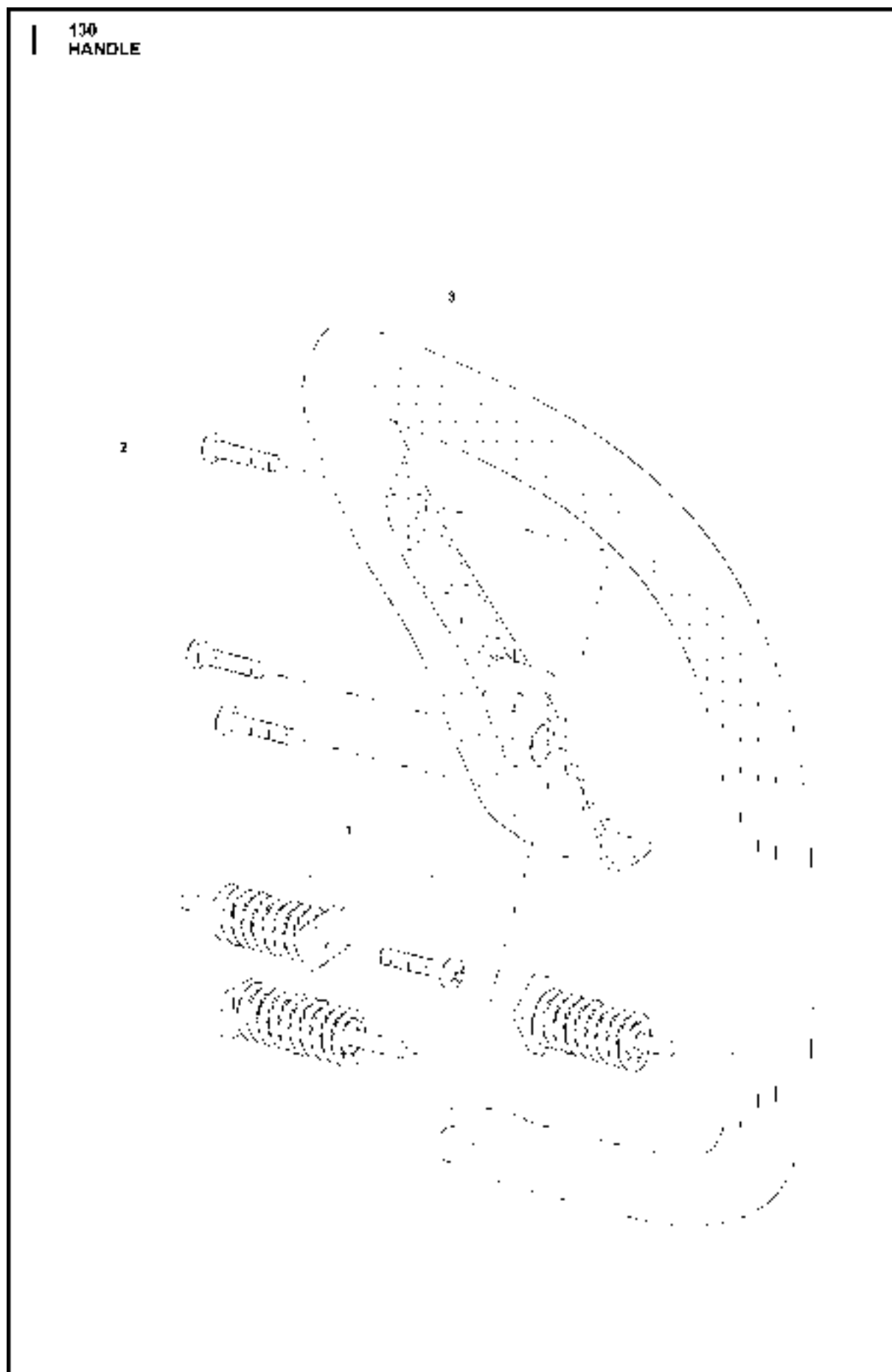

Ref	Part No	Description	Remark	QTY KIT
1	591 46 61-01	SERVICE KIT	Anti-vibration Element	1
2	530 01 64-32	SCREW		3
3	501 31 63-01	HANDLE		1

J 130
IGNITION SYSTEM



Ref	Part No	Description	Remark	QTY	KIT
1	575 96 26-01	SCREW		2	2
2	591 46 65-01	IGNITION MODULE ASSY	From s/n 20205100001 -	1	
2	597 56 40-02	MODULE	- up to s/n 20205099999 (incl screws)	1	
3	544 87 42-02	FLYWHEEL ASSY		1	
4	530 01 51-27	WASHER		1	
5	530 01 61-34	NUT		1	

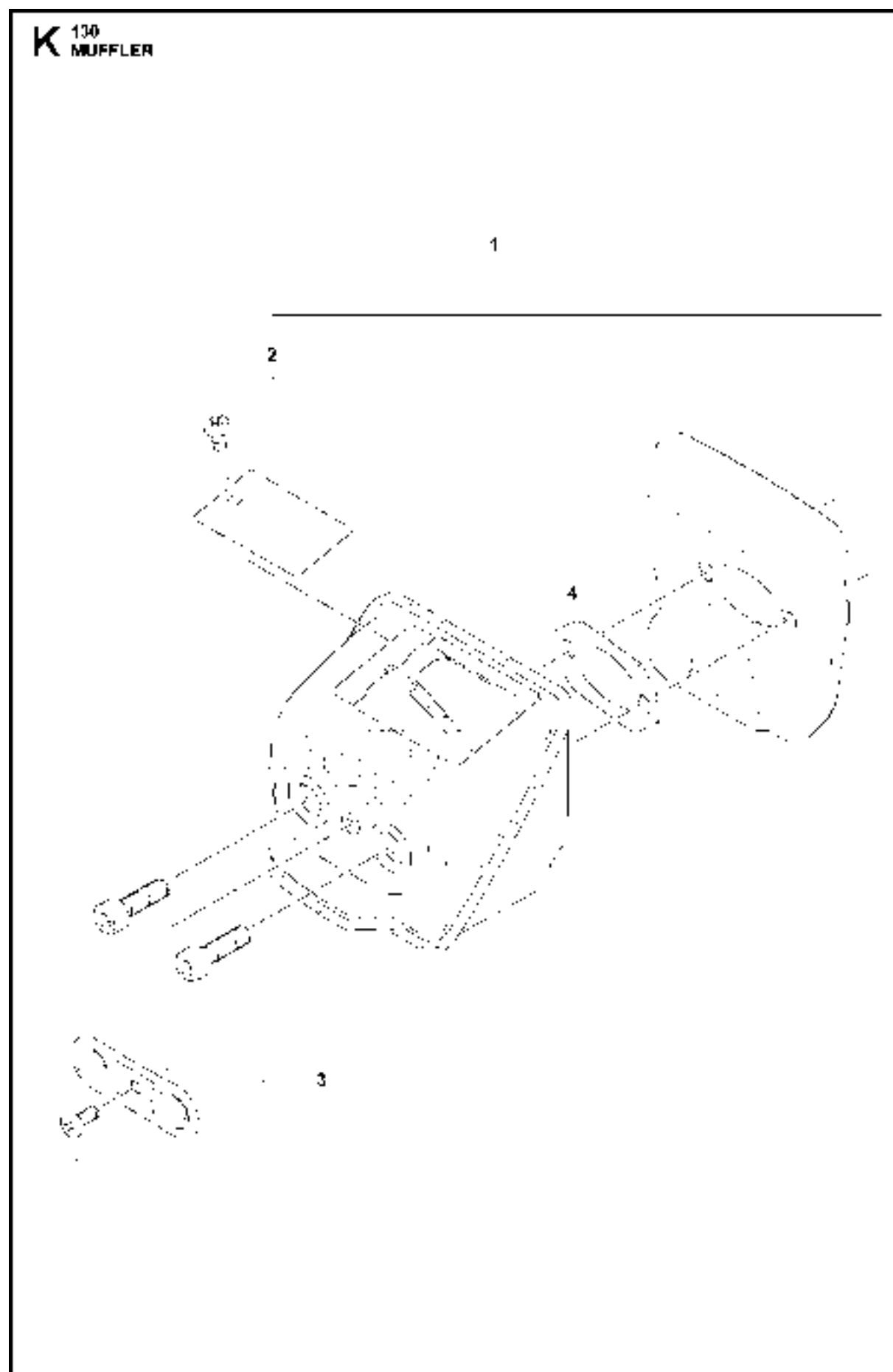

Ref	Part No	Description	Remark	QTY	KIT
1	501 26 62-03	MUFFLER ASSY		1	
2	591 17 55-01	SERVICE KIT	Spark Arrester	1	1
3	591 17 46-01	SCREW KIT	MUFFLER	1	1
4	501 61 95-01	GASKET		1	1

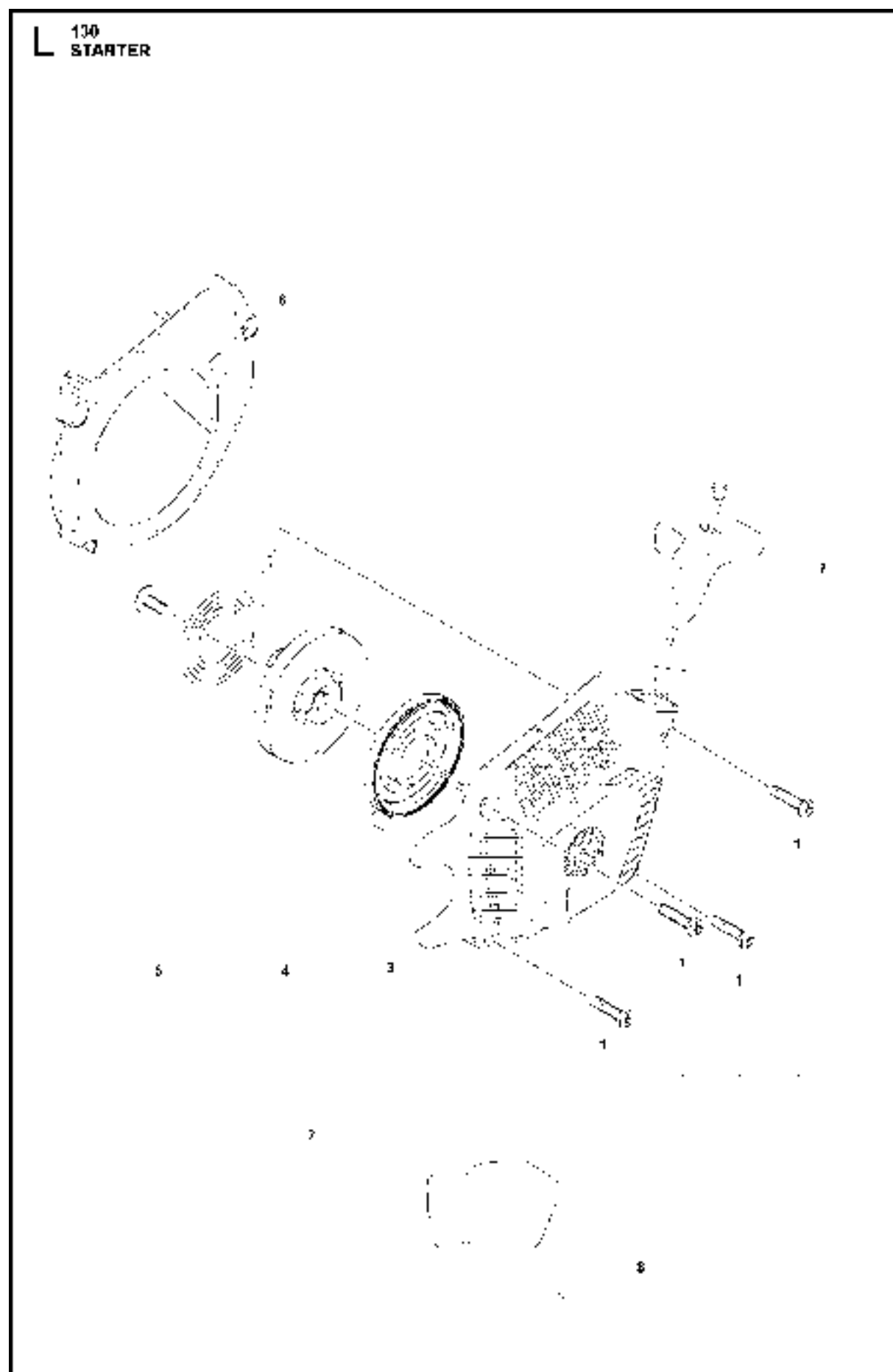

Ref	Part No	Description	Remark	QTY	KIT
1	530 01 64-01	SCREW		4	2
2	591 46 67-01	SERVICE KIT	Starter Housing	1	
3	576 65 78-01	SPRING		1	2
4	588 97 07-01	PULLEY		1	2
5	530 01 59-20	SCREW		1	2
6	588 97 06-01	BAFFLE		1	
7	545 01 00-10	HANDLE	Handle & Rope	1	2
8	591 46 55-01	SERVICE KIT	DECAL KIT	1	

Illustrated part list IPL update

Instruction

Husqvarna Division; Handheld

Husqvarna



Product Name(s)

130

Description of change

Improved performance regarding unstable idle, more easy to start in cold temperatures.

Comments

1. Ignition module.
Old Ignition module 591 46 65-01: Ignition module 579 68 24-01 marked MBU-84 (Incl Screws)
New Ignition Module 597 56 40-02 marked FL39B (without screws).
2. Clutch assy is fully interchangeable.
Spring clutch is fully interchangeable. The Spring is a higher tension spring.
See picture below how to define if chainsaw is equipped with new clutch (New 599 58 85-01 Spring marked with white dot).
3. Carburettor is not interchangeable.
See instruction below how to define which Carburettor the chainsaw is equipped with and which Carburettor kit to use for service.
The Carburettor kits are composed of Carburettor and Valve assy.
4. To upgraded a chainsaw completely to the new performance you need to replace all following parts at the same time and you will need to verify that any excluded part defined in this update is replaced with a new part. Please use instructions below to determine which parts on the chainsaw might already be new.

New Carburettor kit (Carburettor and Valve assy):

599 82 37-03 Service kit with Carburettor marked H225-9 (NA, EU, CN, AU, NZ)

or

599 82 37-04 Carburettor kit with Carburettor marked H225-9-01 (RU, BR).

New Ignition module: 597 56 40-02

New Clutch assy: 599 58 86-01 or **New Spring Clutch** 599 58 85-01

Introduced from

Serial number / Date	Remark
s/n 20205100001	Valid for Carburettor, Ignition module
s/n 20203600001	Valid for Clutch assy and Spring clutch

IPL updates

Page Title	Ref. no	New part no	Name	Excl. part no.	Remark
CARBURETTOR & AIR FILTER	6	599 82 37-01	CARBURETTOR KIT	588 24 79-01	NA, EU, CN, AU, NZ - up to s/n 20205099999
	6	599 82 37-02	CARBURETTOR KIT	593 81 81-01	RU, BR - up to s/n 20205099999
	6	599 82 37-03	CARBURETTOR KIT		NA, EU, CN, AU, NZ From s/n 20205100001 -
	6	599 82 37-04	CARBURETTOR KIT		RU, BR From s/n 20205100001 -
CLUTCH & OIL PUMP	5	599 58 85-01	SPRING	530 09 41-88	
	6	599 58 86-01	CLUTCH	530 01 49-49	

Illustrated part list IPL update

Instruction

Husqvarna Division; Handheld

Husqvarna



Page Title	Ref. no	New part no	Name	Excl. part no.	Remark
IGNITION SYSTEM	2	591 46 65-01	IGNITION MODULE	597 56 40-02	From s/n 20205100001 -

2 & 4. Clutch



New part number:	Old part number:
599 58 86-01 Clutch Assembly	530 01 49-49 Clutch Assembly
599 58 85-01 Spring Clutch (marked with white dot)	530 09 41-88 Spring Clutch

3 & 4. Carburettor

How to define which Carburettor the chainsaw is originally equipped with.



Marked WTA-36
Marked WTA-40



Marked H225-9
Marked H225-9-01

Use Carburettor kit part number:	Use Carburettor kit part number:
599 82 37-01 Carburettor kit: NA, EU, CN, AU, NZ	599 82 37-03 Carburettor kit: NA, EU, CN, AU, NZ
599 82 37-02 Carburettor kit: RU, BR	599 82 37-04 Carburettor kit: RU, BR